

VASE

by Edwin Corrie

1

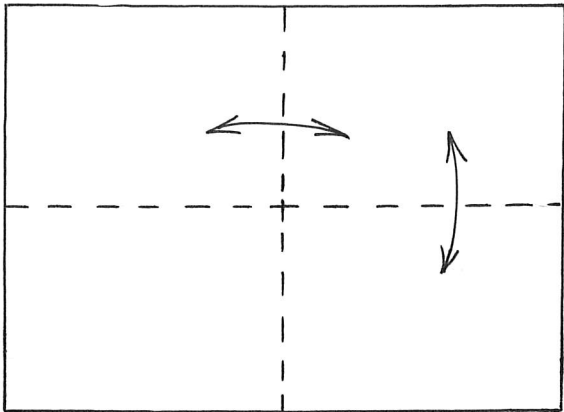

A4 rectangle

2

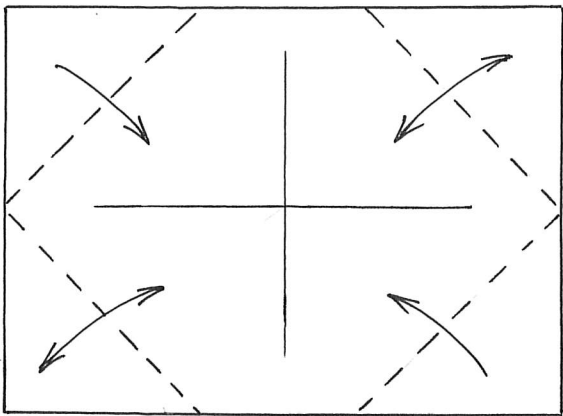

3

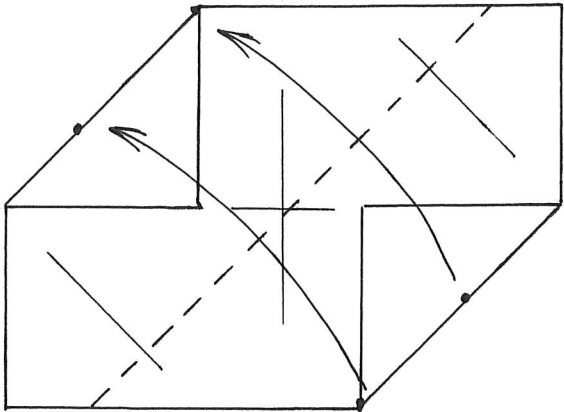

4

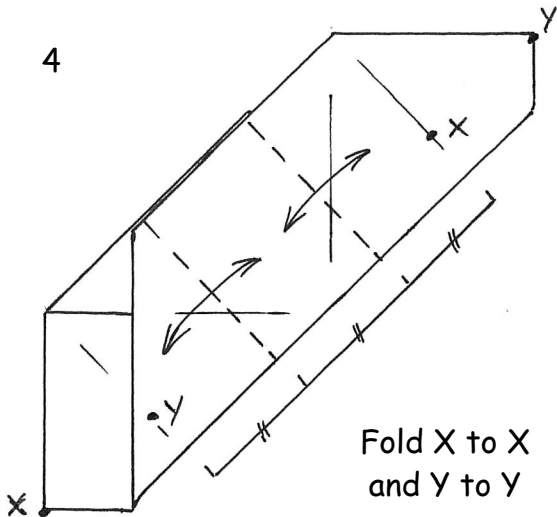

Fold X to X
and Y to Y

5

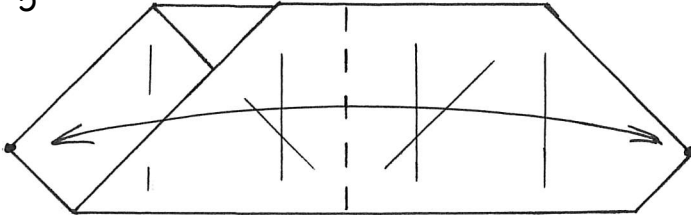

6

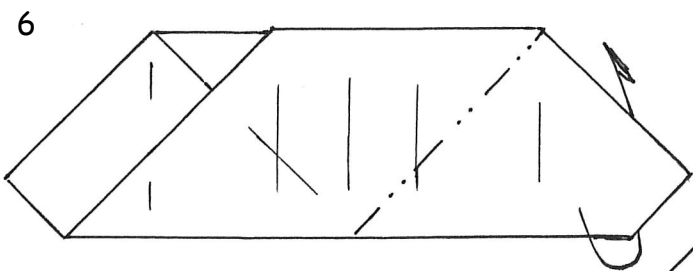

7

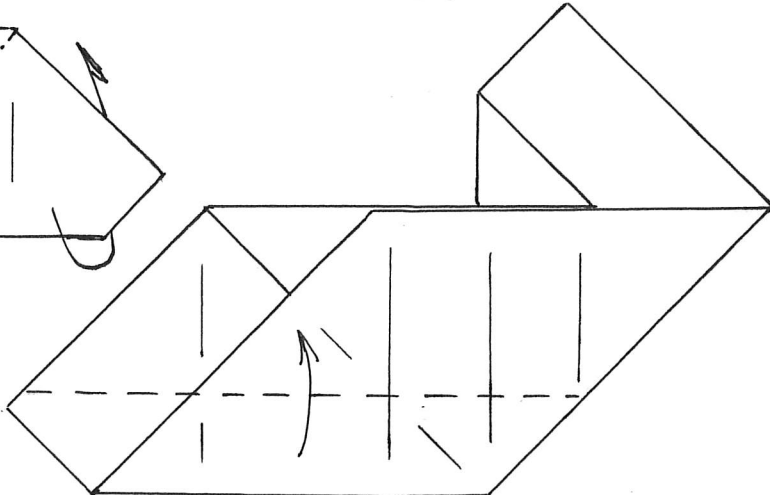

8

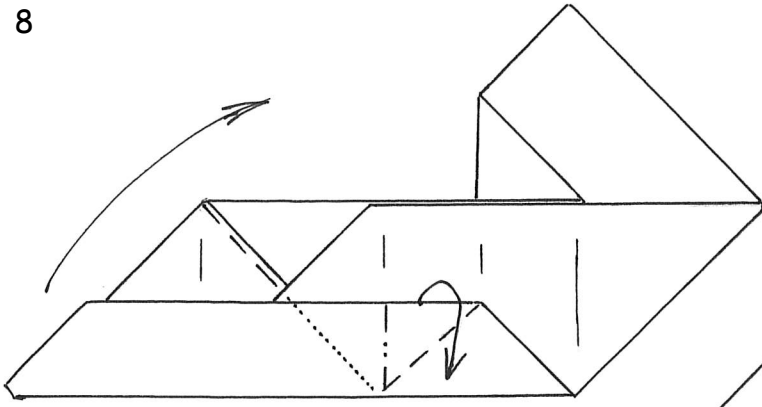

Swivel fold

9

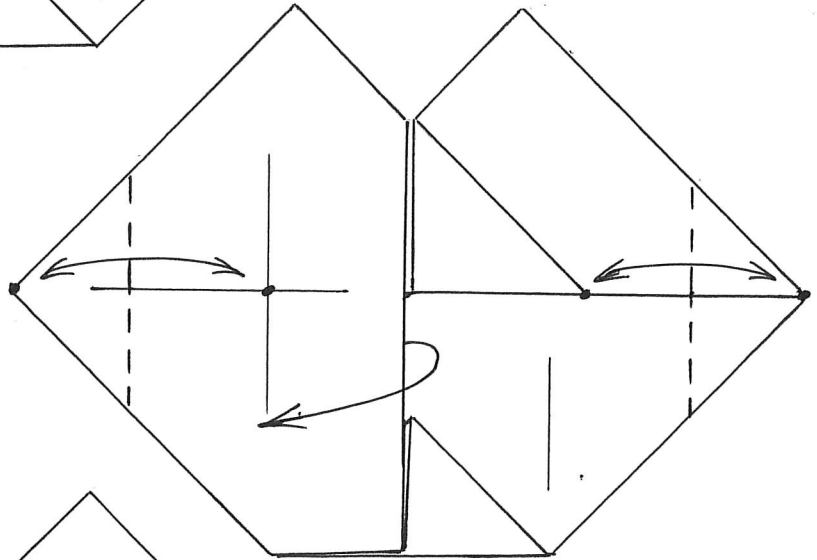

Precrease and unfold to step 7

10

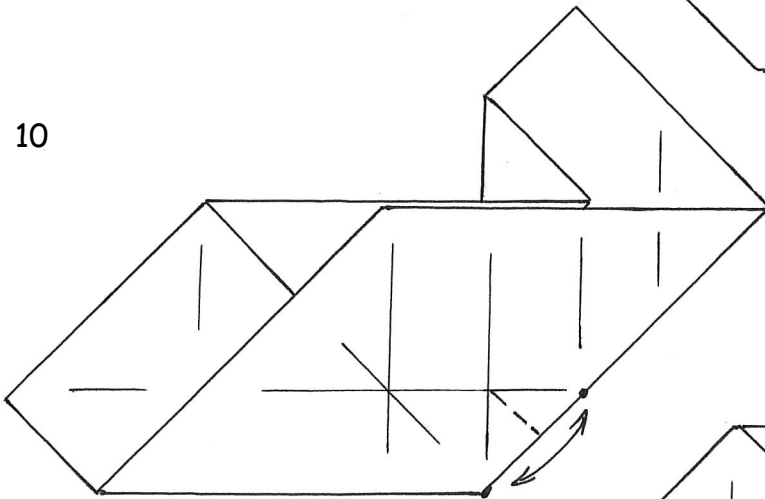

Precrease

11

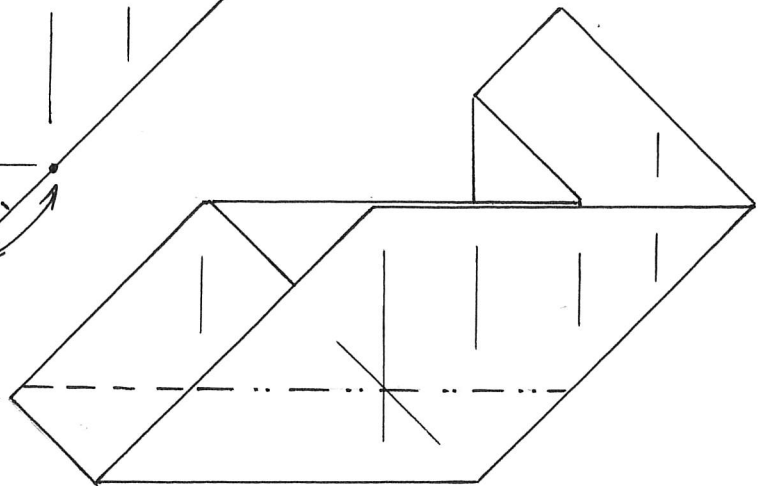

Closed sink

12

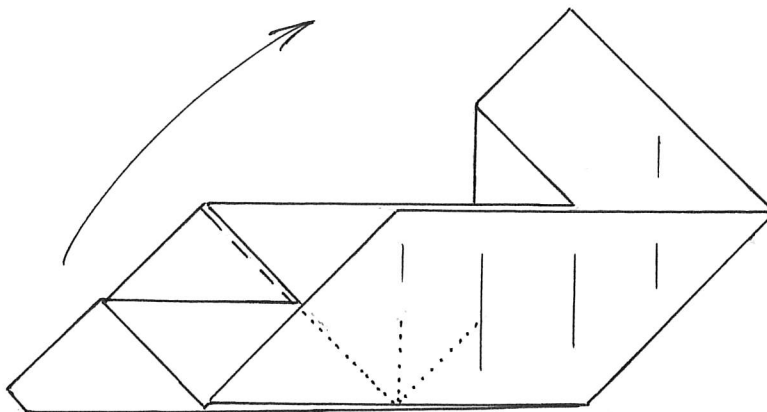

Reinstate the swivel fold of step 8

13

Fold down on the left

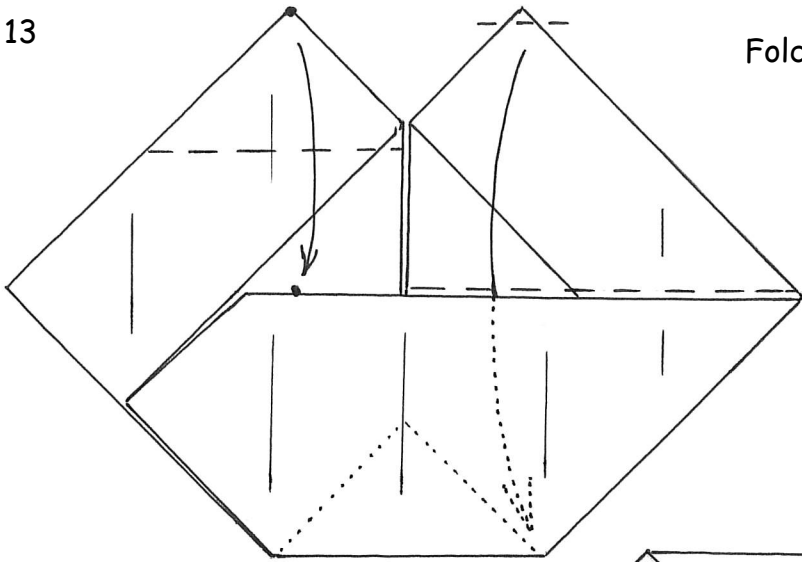

Tuck in on the right

14

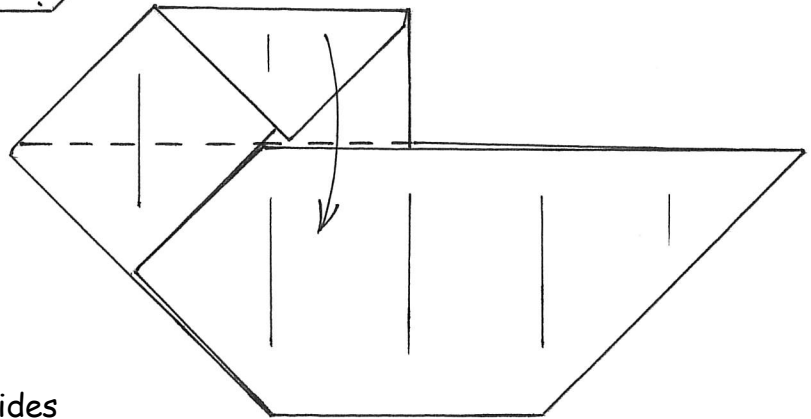

15

Tuck in on both sides

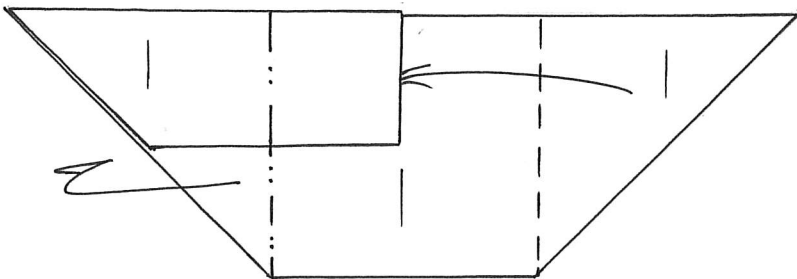

As seen from the bottom

16

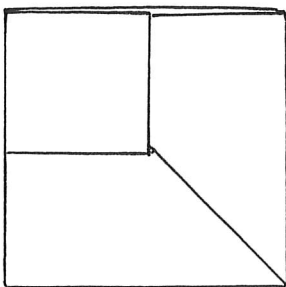

18

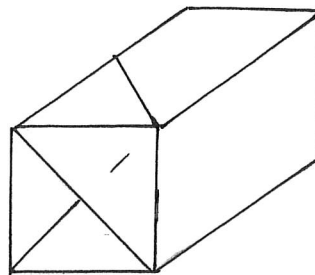

19

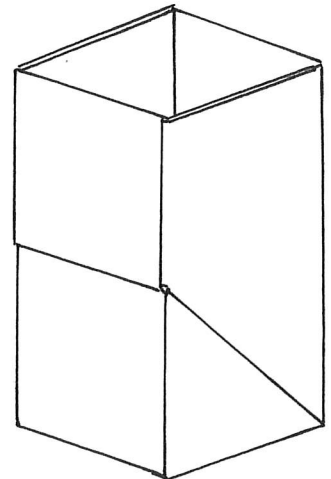

17

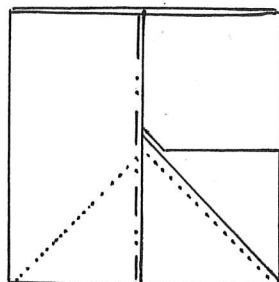

Open into 3D

